

PRODUCED BY



HYDRAULIC MOTOR BLOCKS TYPE BV

DISTRIBUTED BY



BVS 12 08/.. .

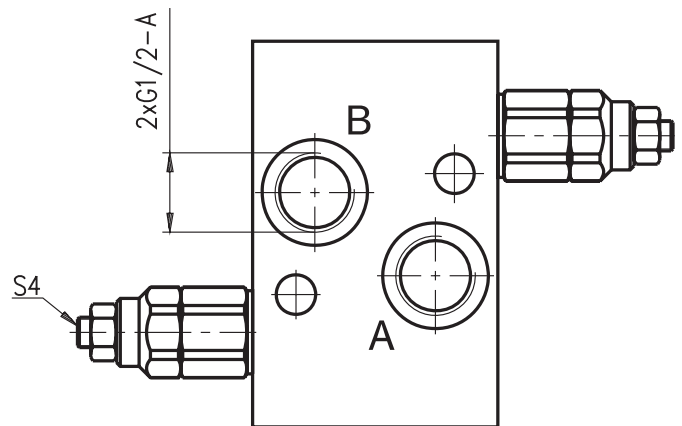
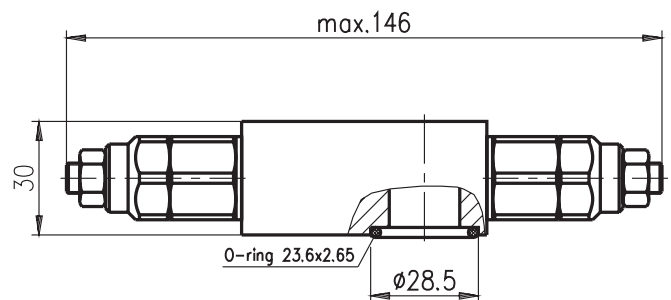
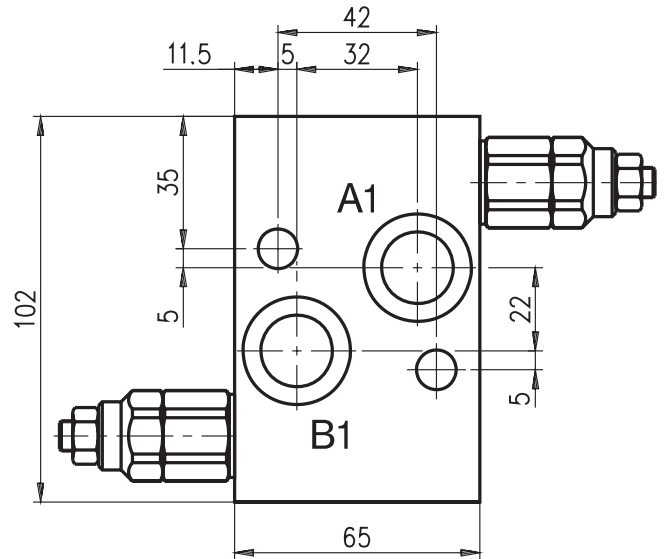
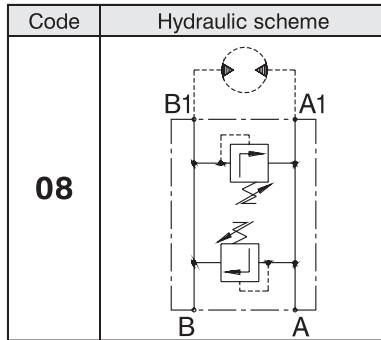

TECHNICAL DATA		
Nominal pressure	bar	250
Nominal flow rate	L/min	50

PRESSURE RANGE			
Code	Standard setting bar (Q=5l/min)	Adj. pressure range bar	Colour
10	80	10...100	White
25	180	30...250	Yellow

Code	ADJUSTMENTS
A	Leakproof hex. socket screw
B	Handknob and locknut

ORDERING CODE

BV S 12 08/10 A

